

标准气缸安装附件

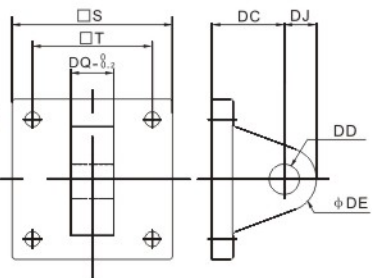

符号/缸径	32	40	50	63	80	100	125	160	200
S	48	50	62	75	94	112	140	180	220
T	33	37	47	56	70	84	110	140	175
DC	34	34	34	34	48	48	50	55	60
DD	14	14	15	15	20	20	25	30	30
DE	12	14	14	14	20	20	25	30	30
DJ	14	14	15	15	20	20	25	30	30
DQ	16	20	20	20	32	32	70	90	90

CA 型单耳

标准气缸安装附件

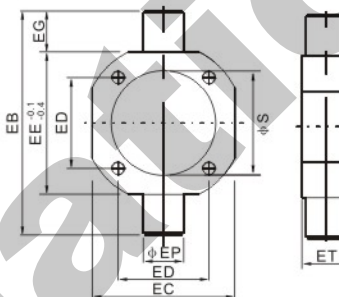

符号/缸径	40	50	63	80	100	125	160	200
EB	113	126	138	164	182	210	264	336
EC	63	76	88	114	132	160	200	240
ED	37	47	56	70	84	110	140	175
EE	63	76	88	114	132	160	200	240
EG	25	25	25	25	25	25	32	48
EP	25	25	25	25	25	25	32	37
ET	30	30	30	30	40	30	38	44
S	45.5	55.5	68.5	87.5	107.5	134.5	172.5	212.5

TC 型中摆

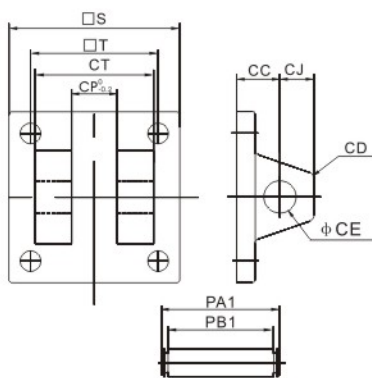

符号/缸径	32	40	50	63	80	100	125	160	200
CC	19	19	19	19	32	32	50	55	60
CD	5	5	3	2	8	8	25	30	30
CE	12	14	14	14	20	20	25	30	30
CJ	13	13	15	15	21	21	25	30	30
CP	16	20.5	20.3	20.3	32.3	32.3	70	90	90
CT	32	44	52	52	64	64	120	160	160
PA1	41	51.8	60.3	60.3	73.8	73.8	130	170	170
PB1	33.5	45.8	54	54	65.5	65.5	121.5	161.5	161.5
S	48	50	62	75	94	94	140	180	220
T	33	37	47	56	70	70	110	140	175

■ 从缸径 32-100的CA和CB, 我们可以提供2种不同材质的产品, 1.铁 2.铝, 请在下订单时标明材质, 从125-200 全部为铁。

CB + Pin 型双耳

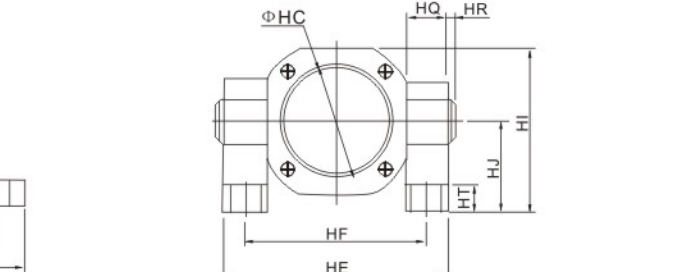
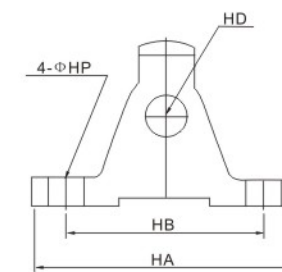

TC-M 型中摆+脚座

符号/缸径	HA	HB	HC	HD	HE	HF	HI	HJ	HQ	HR	HT	HP
40	110	80	45.5	22	109	86	81.5	50	23	2	12	12
50	110	80	55.5	22	122	99	88	50	23	2	12	12
63	110	80	68.5	22	134	111	94	50	23	2	12	12
80	120	85	87.5	22	160	137	127	70	23	2	14	14
100	120	85	107.5	22	178	155	136	70	23	2	14	14

迷你气缸安装附件

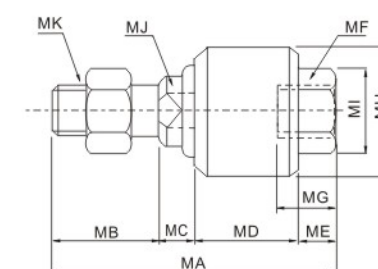

M-UJ 型浮动接头

符号/缸径	MA	MB	MC	MD	ME	MF	MG	MH	MI	MJ	MK
20	51	20	6	17	8	M8×1.25	12	24	13	8	M8×1.25
25	58	22	7	21	8	M10×1.25	12	26	17	10	M10×1.25
32	58	22	7	21	8	M10×1.25	12	26	17	10	M10×1.25
40	58	22	8	21	7	M12×1.25	12	28	19	12	M12×1.25

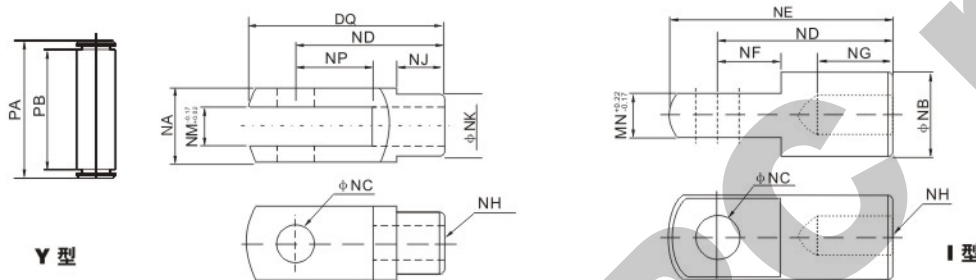

Y 型

I 型

Y+销子型接头

Symbol/Bore	32	40	50	63	80	100	125	160	200
NA	19	25.4	32	32	44.4	44.4	55	80	80
NB	20	24	32	32	40	40	45	54	54
NC	10	12	16	16	20	20	25	30	30
ND	40	48	64	64	80	80	110	120	120
NE	52	67	89	89	112	112	155	130	130
NF	15	24	32	32	40	40	40	35	35
NG	20	20	23	23	30	30	56	50	50
NH	M10×1.25	M12×1.25	M16×1.5	M16×1.5	M20×1.5	M20×1.5	M27×2	M36×2	M36×2
NJ	12	20	22	22	30	30	30	40	40
NK	18	23	30	30	39	39	54	54	54
NM	10	12	16	16	20	20	48	40	40
MP	20	24	32	32	40	40	64	35	35
NQ	52	62	83	83	105	105	148	150	150
PA	25	32.8	39.3	39.3	53.3	53.3	64	91	91
PB	19.5	26.5	33	33	45	45	55	81	81

I 型接头

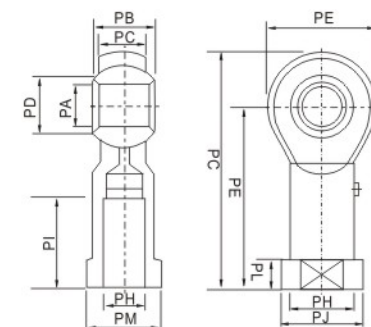

M-PHS 型鱼眼接头

符号/缸径	PA	PB	PC	PD	PE	PF	PG	PH	PI	PJ	PK	PL	PM
20	8	12	9	10.4	22	36	47	M8×1.25	17	16	12.5	5	14
25	10	14	11	12.9	26	43	56	M10×1.25	21	19	15	6.5	17
32	10	14	11	12.9	26	43	56	M10×1.25	21	19	15	6.5	17
40	12	16	12	15.4	30	50	65	M12×1.25	24	22	17.5	6.5	19

迷你气缸配件



M-FA 型法兰板

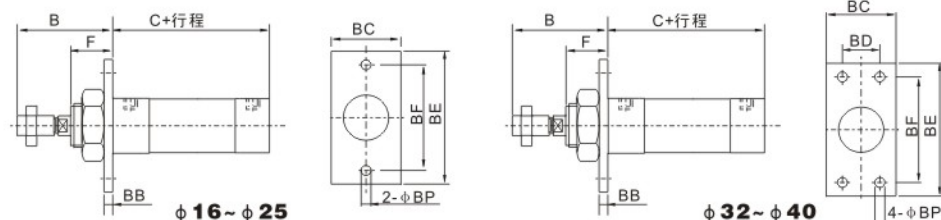

NEW



M-FA-A 型法兰板

符号/缸径	B	C		C(MSA 系列)		C(MSAL 系列)		BB	BC	BD	BE	BF	BP	F
		MA 系列	MAL 系列	0-50	51-100	0-50	51-100							
16	38	60	-	60	85	-	-	3	26	-	52	40	5.5	16
20	40	76	70	76	101	70	95	4	38	-	64	50	6.5	12
25	44	76	70	76	101	70	95	4	38	-	64	50	6.5	14
32	44	76	70	76	101	70	95	4	47	33	72	58	6.5	14
40	46	76	92	76	101	92	117	4	50	36	84	70	6.5	14

■ 我公司还可提供此类用于迷你气缸法兰板, 如果你需要此类产品, 请在全部订购码后加上"A", 如M-FA-32-A.



M-LB 型支架

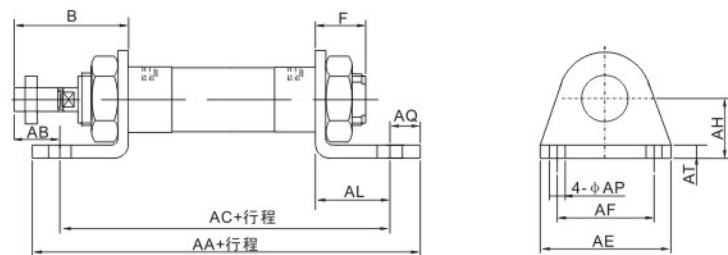

符号/缸径	B	F	AA (MA 系列)		AA (MAL 系列)		AA(MSA 系列)		AA(MSAL 系列)		AB	AC (MA 系列)		AC (MAL 系列)		AC(MSA 系列)		AC(MSAL 系列)		AE	AF	AL	AQ	AP	AT	AH
			0-50	51-100	0-50	51-100	0-50	51-100	0-50	51-100		0-50	51-100	0-50	51-100											
			16	38	16	98	-	98	123	-		-	25	86	-	86	111	-	-							
20	40	12	122	116	122	147	116	141	25	106	100	106	131	100	125	54	40	15	8	6.5	3	25				
25	44	14	122	116	122	147	116	141	29	106	100	106	131	100	125	54	40	15	8	6.5	3	25				
32	44	14	142	136	142	167	136	161	19	126	120	126	151	120	145	59	45	25	8	6.5	4	32				
40	46	14	142	158	142	167	158	183	21	126	142	126	151	142	167	64	60	25	8	6.5	4.5	36				



M-SDB 型支架

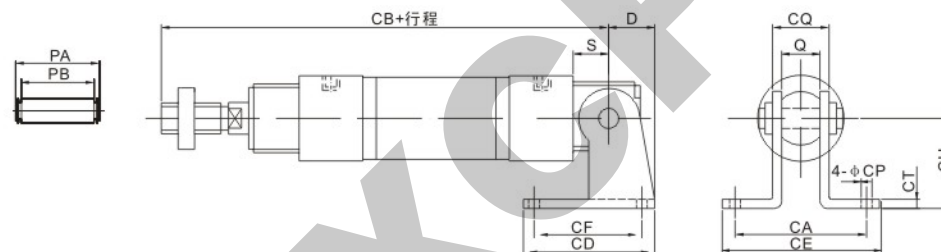

符号/缸径	D	S	Q	CA	CB(MA 系列)		CB (MSA 系列)		CB (MSAL 系列)		CD	CE	CF	CH	CT	CP	CQ	PA	PB
					0-50	51-100	0-50	51-100	0-50	51-100									
16	16	9	12	-	107	-	107	132	-	-	23	-	12	20	2.3	5.5	16.5	21	17
20	21	12	16	51	128	122	128	153	122	147	48	67	32	32	3	6.5	22	27	22.5
25	21	12	16	51	132	126	132	157	126	151	48	67	32	32	3	6.5	22	27	22.5
32	27	15	16	51	135	129	135	160	129	154	52	67	36	36	4	6.5	24	30	24.5
40	27	15	20	55	137	153	137	162	153	178	56	71	40	40	4	6.5	28	34	28.5

迷你气缸配件

M-Y 接头



M-Y+销子 M-Y+卡扣



M-I 接头

符号/缸径	NA	NC	ND	NE	NF	NG	NH	NJ	NK	NL	NM	NN	NP	NQ	PA	PB
20	16	8	30	40	11	15	M8×1.25	10	16	14	8	8	15	40	21	16.5
25	19	10	40	52	15	20	M10×1.25	12	20	18	10	10	20	52	25	19.5
32	19	10	40	52	15	20	M10×1.25	12	20	18	10	10	20	52	25	19.5
40	25.4	10	45	57	15	25	M12×1.25	15	24	23	14	10	20	57	31	26

M-U+销子 接头

符号/缸径	B	E	C	H	L	N	O	R	S	G	BT	CG	CH	BU	S
8/10	4.5	4	12.5	24	20	8.1	13	5	2.5	4	14	3.7	0.5	17	0.2
12/16	5.5	6	15	27	25	13	18	7	3	6	19	5.6	0.8	24	0.4
20/25	6.6	8	20	29.5	32	16.1	24	10	4	8	25.2	7.5	0.9	29.5	0.5

特殊气缸配件

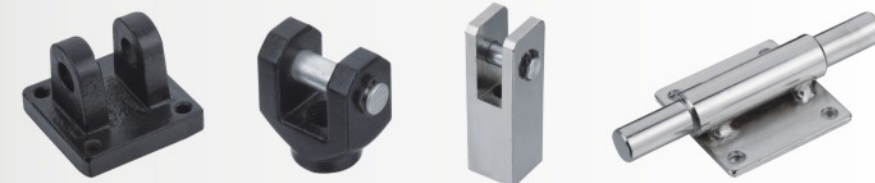

■ 我公司可以为客户定制各类非标准气缸配件, 我们将会根据您提供的图纸或样品来制作.